

PREINSTALLATION
VORINSTALLATION

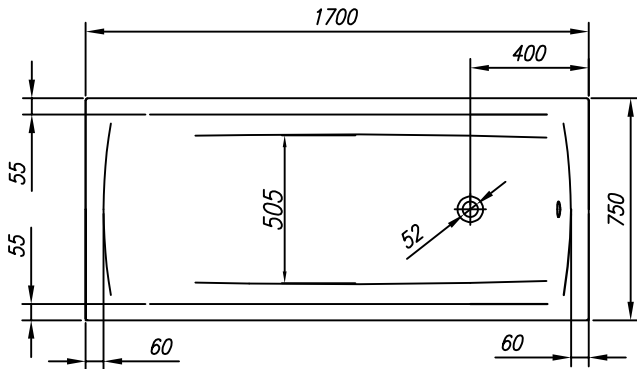

VOLUME (l)
VOLUMEN (l)

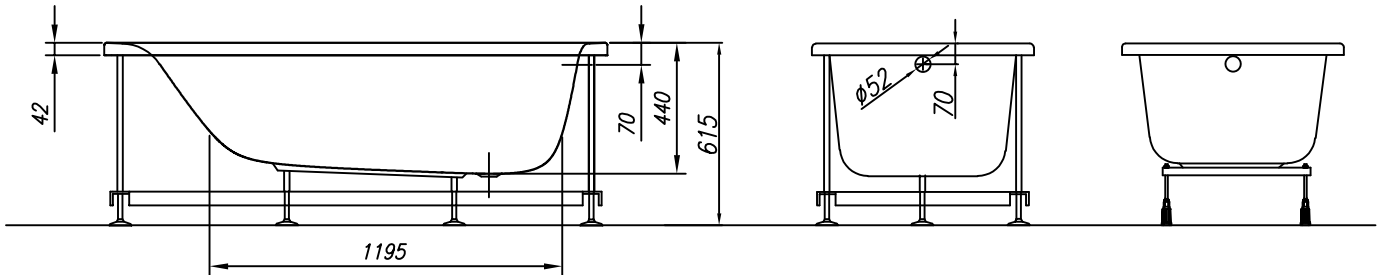

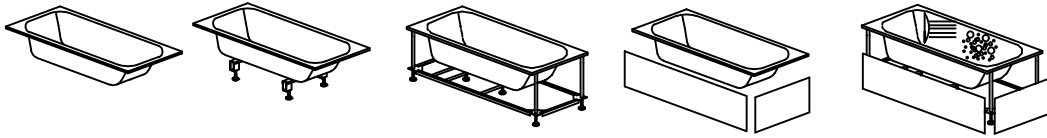





MAX. LOAD (kg)
MAX. BELASTUNG (kg)

FLOOR LOAD (kg/m²)
BODENBELASTUNG (kg/m²)

200

365

285

-  - Spot for el. cable 3×2.5mm², length approx. 1m
-  - Platz Stromkabel 3 × 2,5 mm², Länge cca. 1 m
-  - Spot for el. cable 1×6mm² for earthing, length approx. 1.5m
-  - Platz Stromkabel 1 × 6 mm² für Erdung, Länge cca. 1,5 m
-  - Drain spot Ø 50mm
-  - Abflussplatz Ø 50 mm
-  - Panel - option
-  - Möglichkeit - Schürze

INSTALLATION RECOMMENDATION
MONTAGEEMPFEHLUNG

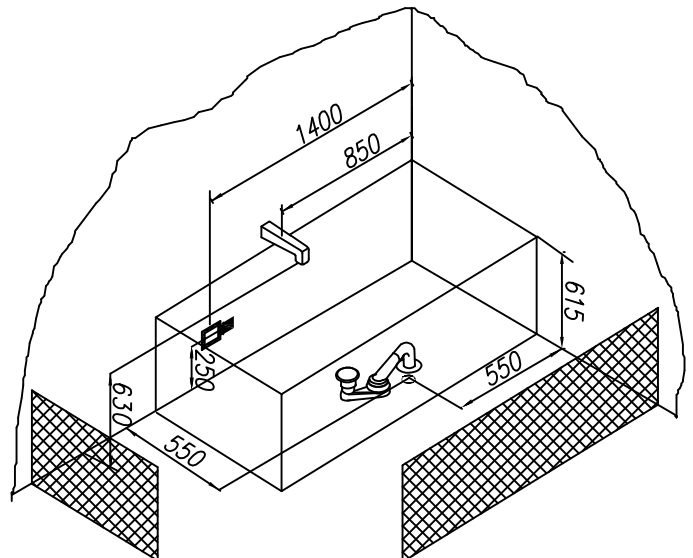

Recommended overflow set Vorgeschlagene Überlaufgarnitur	PAL 650
Recommendations for the installation of bathtub without panel Empfehlungen für die Montage von Badewannen ohne Schürze	Nr. MK 03
Recommendations for the installation of bathtub with panel Empfehlungen für die Montage von Badewannen mit Schürze	Nr. MK 01
Option of the built-in bathtub base Möglichkeit des Sockels für die Badewannen ohne Schürze	Nr. MK 05 PKK 501
Option of the bathtub base with panel Möglichkeit des Sockels für die Badewannen mit Schürze	Nr. MK 20 Set EAN code

- | | | | | |
|---|---|---|--|--|
|  - PUMP
- WASSERPUMPE |  - WATER JETS
- WASSERDÜSEN |  - AIR CONTROLLER
- LUFTREGLER |  - ELECTRONIC SWITCHES
- ELEKTROSCHALTER |  - FIXTURE AND SHOWER HANDLE
- WASSERHAHN UND DUSCHE |
|  - BLOWER
- LUFTPUMPE |  - AIR JET
- LUFTDÜSE |  - PNEUMATIC SWITCH
- PNEUMATIKSCHALTER |  - LIGHT OR CHROMOTHERAPY
- LICHT- ODER CHROMOTHERAPIE |  - MICROJET SWITCH
- SCHALTER FÜR MIKRODÜSEN |

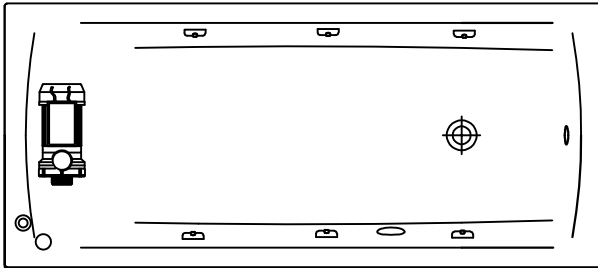

WATER MASSAGE SYSTEM 1 WASSERMASSESYSTEM 1

- | | |
|--------------------|-------------------------|
| - PUMP P=800W | - WASSERPUMPE P = 800 W |
| - PNEUMATIC SWITCH | - PNEUMATIKSCHALTER |
| - AIR CONTROLLER | - LUFTREGLER |
| - 6 WATER JETS | - 6 WASSERDÜSEN |

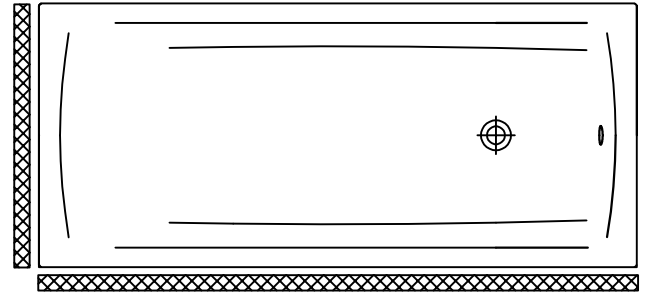

- OPTION PANEL FOR BATHTUB - OPTION SHÜRZE FÜR BADEWANNE

